

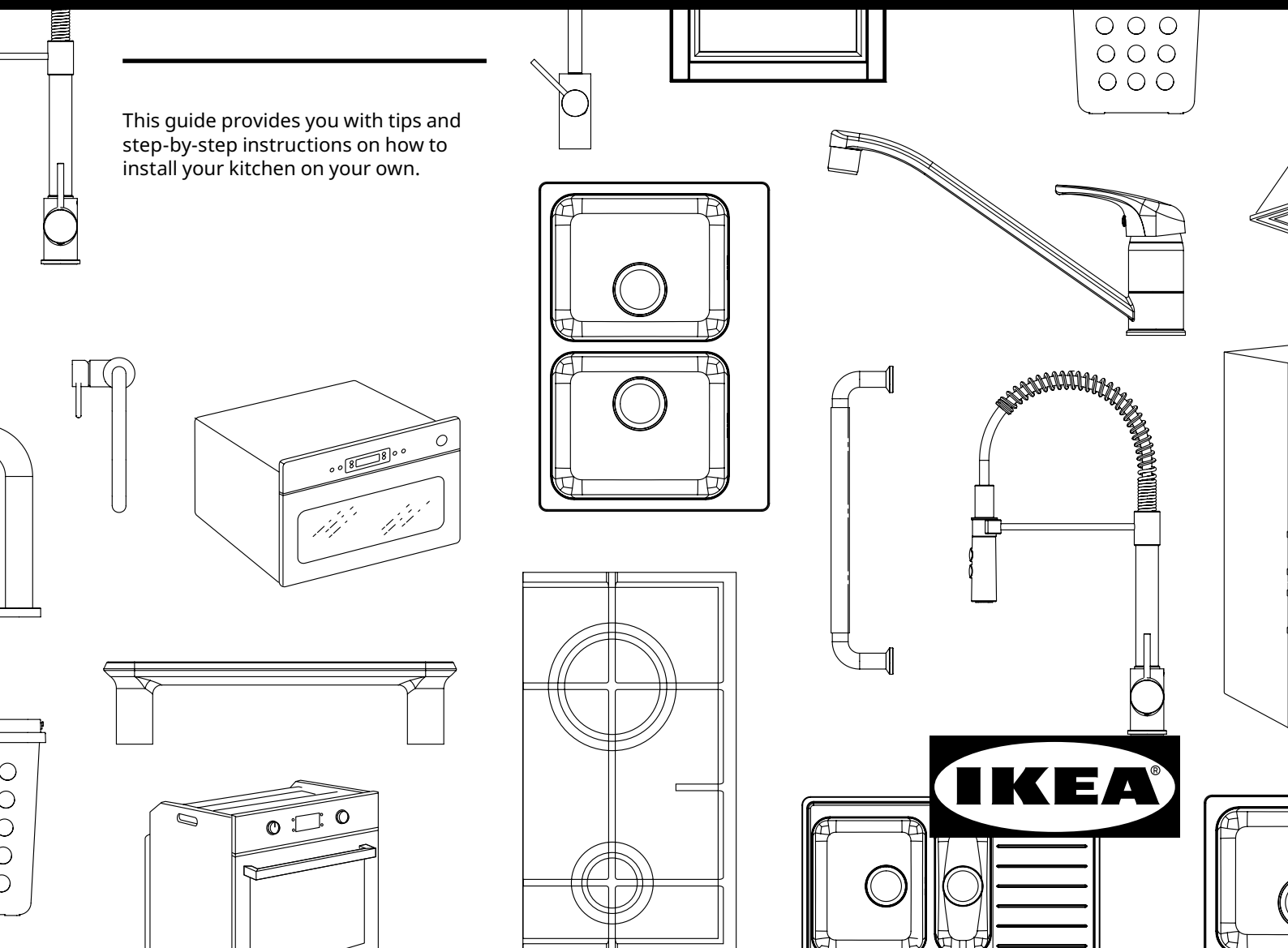

***A guide to
install a new
IKEA kitchen***

INSTALLATION GUIDE



This guide provides you with tips and step-by-step instructions on how to install your kitchen on your own.



The step-by-step guide

Installing your new IKEA kitchen correctly

This brochure is your guide to preparing and installing your new kitchen yourself. Inside you'll find clear steps to follow as well as useful tips and ideas. Use this guide along with your IKEA assembly instructions to make sure your kitchen is installed in the right way.

Before you begin

Go through this brochure before you begin to see what stages are involved in putting in your new kitchen and to organize what tools you'll need.

To make sure you have everything for your new kitchen, compare the packages and parts you have at home against the order list and the freight list. You should only dismantle your old kitchen when you have all your new parts and appliances. Your kitchen parts and countertop should be stored indoors, with normal room temperature and humidity.

It's helpful if you arrange your cabinets in the order you will be installing them. Use your packing list and

IKEA home planner drawing to help you.

Before you remove your old kitchen you need to make sure that your electricity, gas and water is shut off. Use a qualified professional to disconnect and connect your gas, water and electricity.

You can do it yourself but you don't have to

Our kitchens are designed to be as simple as possible for you to assemble and install yourself. But we're here to help as much as you'd like us to. We can offer you services ranging from planning and delivery to complete kitchen installations. For more details see the back page of this guide, the kitchen section of IKEA-USA.com or contact your local IKEA store.



The tools you'll need

Below is a summary of the basic tools you'll need. In addition you'll find what tools to use for each product in their respective assembly instructions. It's a good idea to wear safety glasses when using power tools.

Good to know

Plaster, wood or concrete walls? Because there are many different types of walls, hardware is not supplied with your cabinets. Most hardware or home improvement stores stock appropriate hardware and can help you choose the right sort for your walls.

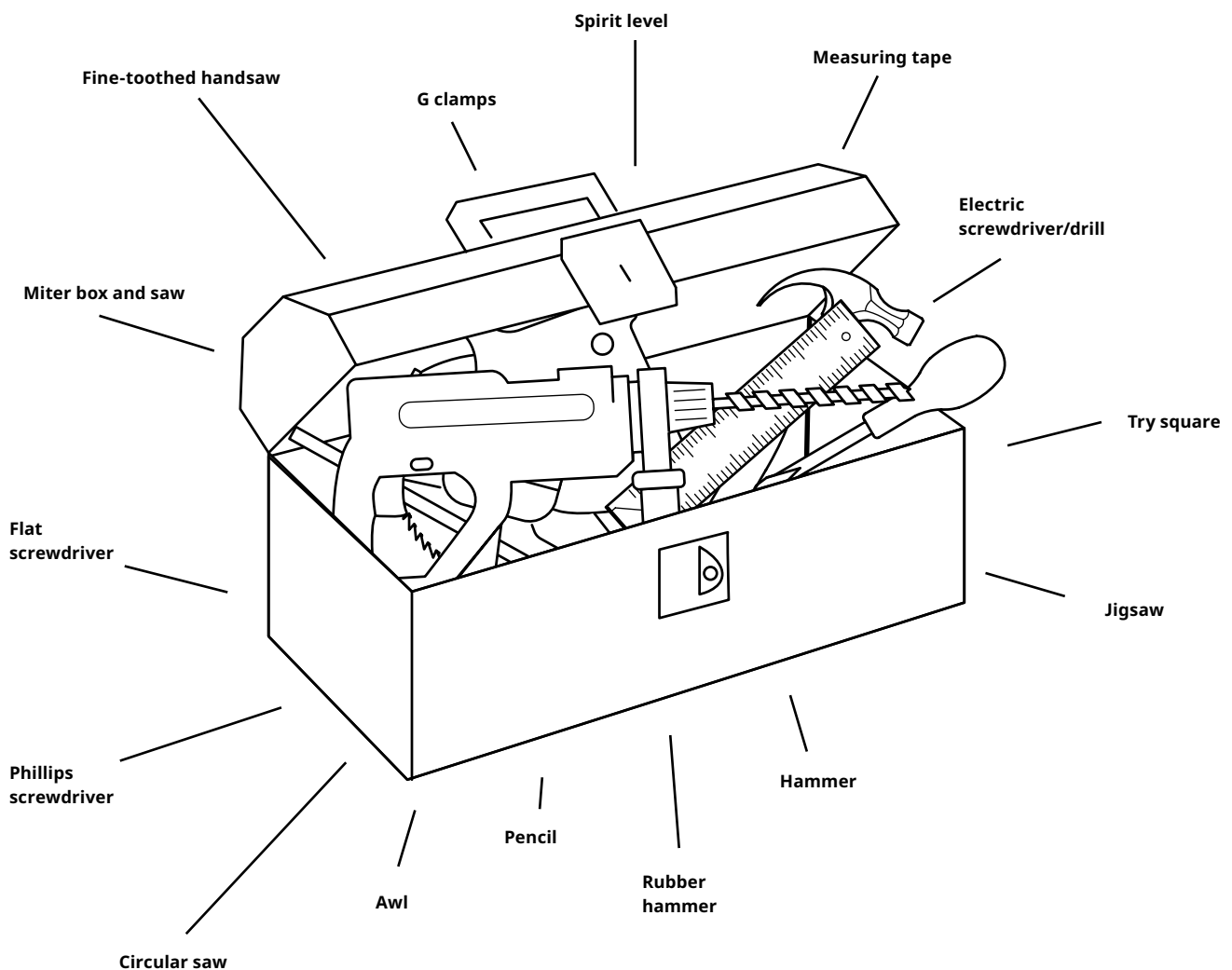

Prepare your room

Once you've removed your old kitchen, prepare the room by making sure your walls and floors are even, and your walls are suitable for supporting your new kitchen. Now is also the time to prime and paint your walls, put tiles on the walls and floors or change your flooring.

Marking cabinet positions

Draw a layout of your new kitchen directly on the wall. Check that everything fits with the measurements from your plan and your electricity, water, gas and ventilation connections are where you want them to be. Also mark where to fasten your new kitchen's suspension rails.

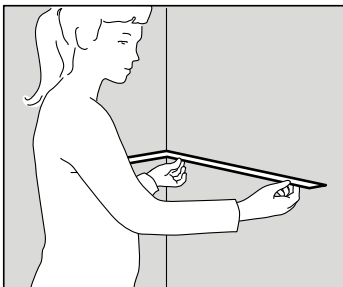

Prepare your space by making sure your corners are even and your walls and floor are straight. Use your try square for the corners and a spirit level for the walls and floor.

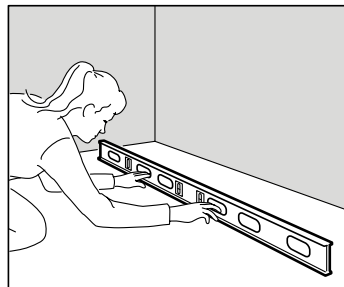

Make sure you note the highest point of the floor and where the corners aren't 90 degrees.

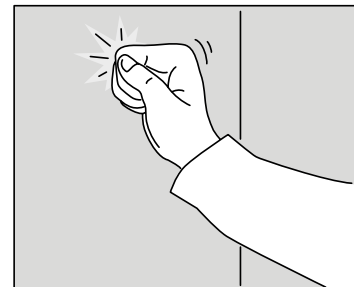

Check your wall is strong enough to hang your suspension rail and cabinets. Depending on your wall material, it's best to install your rail onto a stud or a support beam. An electronic stud finder can be helpful.

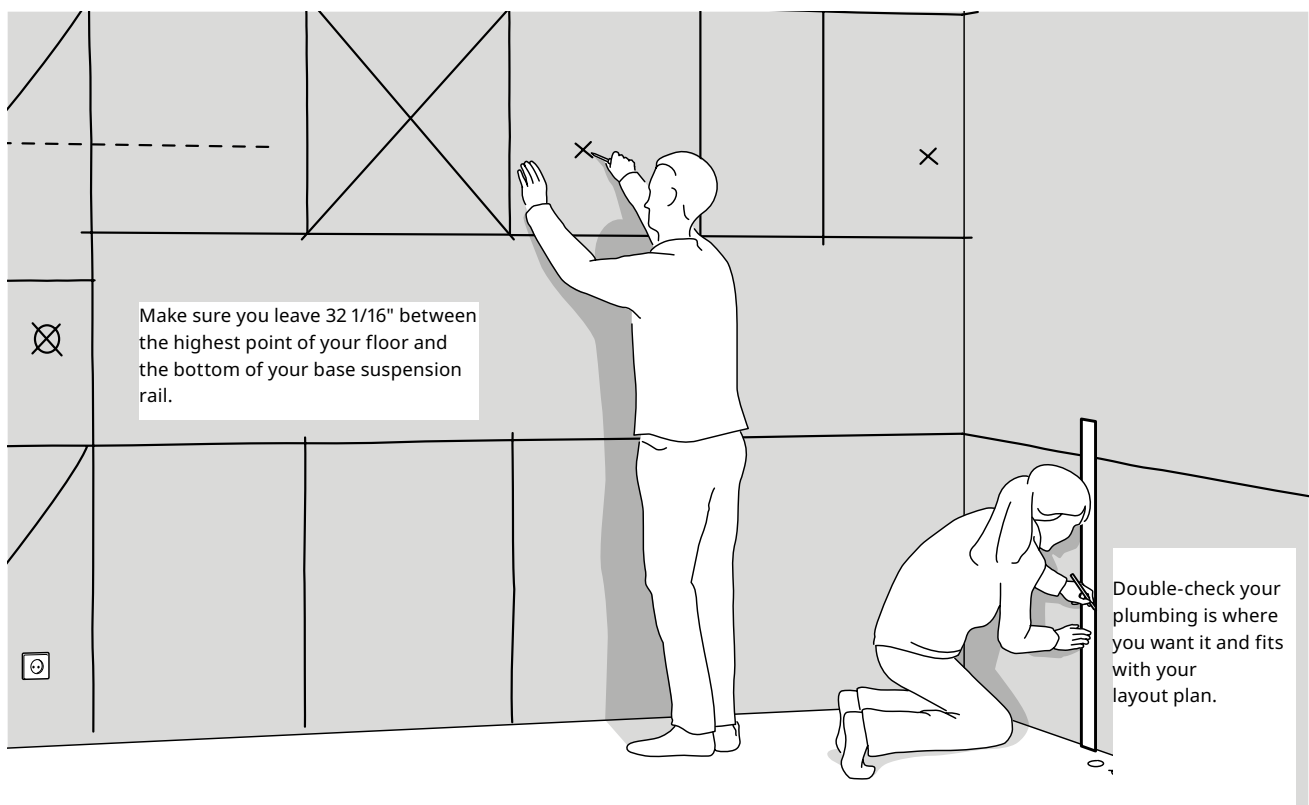

Mount the suspension rails

Your new IKEA cabinets can be hung directly onto a suspension rail making them easier to install and adjust. It's important to make sure your suspension rail is straight and level, and to secure it with the right screw type for your wall.

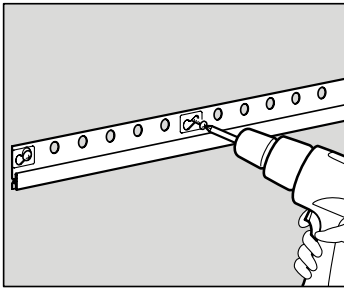

Fasten your rails, base cabinet rails first. Make sure you've found suitable points in the wall where the rails can be fastened and that the rails are level before drilling.

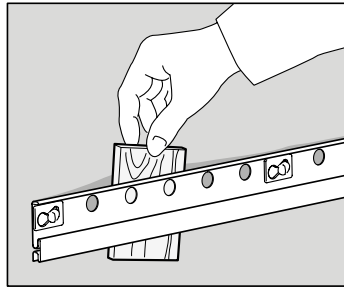

If your wall is uneven use distances between the rail and the wall to make sure the rail is straight.

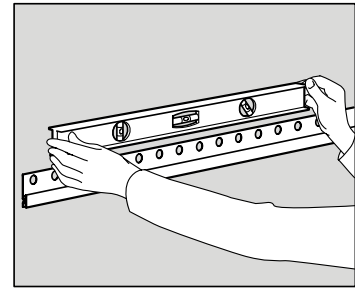

Use a spirit level to check that each rail is level.

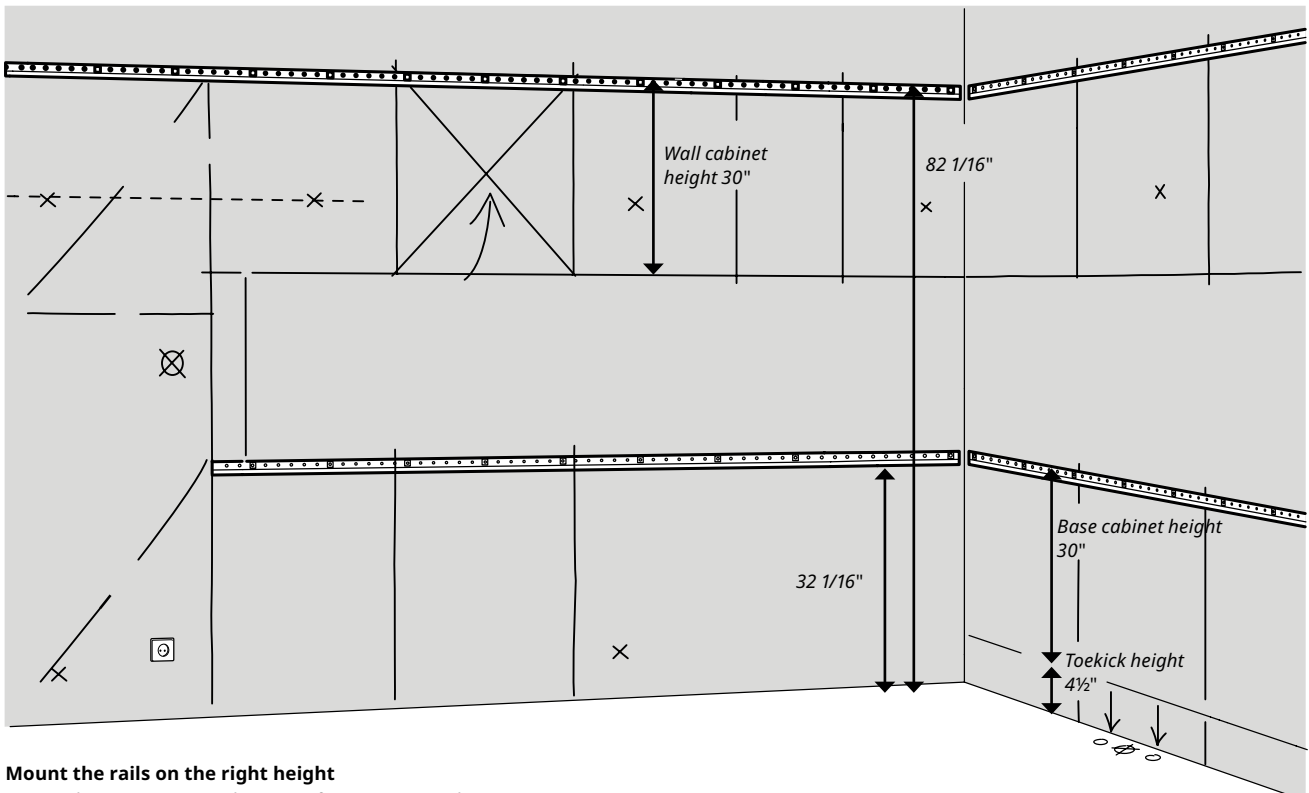

Mount the rails on the right height

Base Cabinets 32 1/16" to bottom of suspension rail or 34 1/4" to top.

30" wall cabinets 82 1/16" to bottom of suspension rail or 84 1/4" to top.

40" wall cabinets 92 1/16" to bottom of suspension rail or 94 1/4" to top.

Must have 1/2" in clearance above wall cabinet suspension rail to enable installation, cabinets must be lifted onto rail.

Measurements provide 20" between bottom of wall cabinet and counter with 1 1/2" in thick countertop.

Install your cabinets

In most kitchens it's best to install your wall cabinets first. This way you have room to move without base cabinets in the way. One exception is if you're installing a single line kitchen with a high cabinet at one end. In this case install the high cabinet first.

Use a jigsaw to create openings for plumbing and utilities if needed. Do this before fitting the cabinet in place. Be aware where you place openings as it can affect how you can arrange drawers in a cabinet.

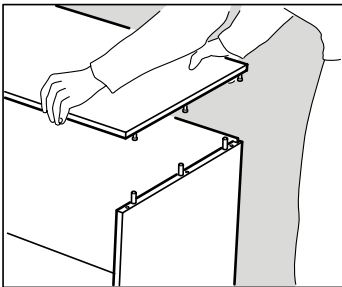

Assemble all wall cabinet frames according to the assembly instructions. Wait until later before fitting drawers, doors and internal fittings.

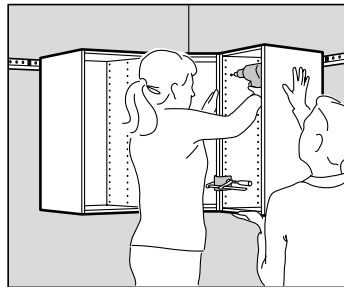

Hang the corner cabinet first and secure by tightening the screws. Hang the remaining cabinets and connect them with the included screws. Wait to tighten the screws until the base cabinets are in place and you can ensure alignment.

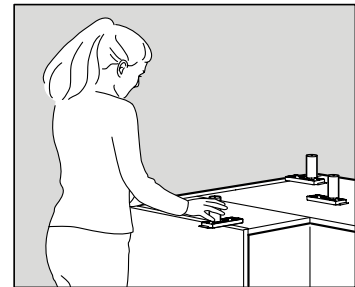

Assemble all base cabinets according to the assembly instructions. Make sure to have the legs attached in the order the cabinets will be fitted.

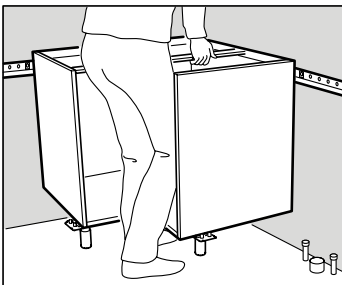

Hang your base cabinets starting in the corner. Hang each following cabinet in the same way. If you're installing a corner carousel now is the time to do it.

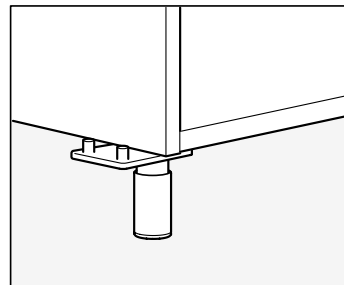

Cabinet legs connecting two cabinets can be used to support both cabinets while you're installing. Remember to use the distance ring included with the legs.

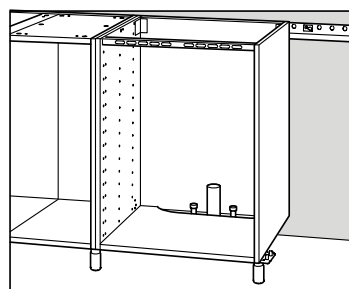
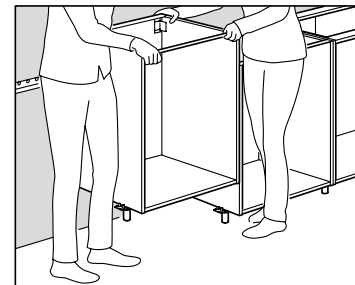

Make sure the right base cabinet is aligned with your plumbing.

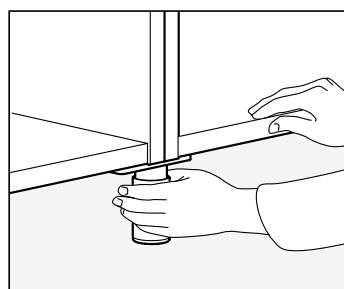

Check that each cabinet is aligned with the previous cabinet by adjusting the legs.

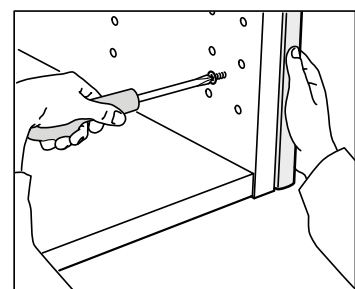

If you're using a high cabinet, fit with a cover panel first.

Filler pieces

Filler pieces are used between your cabinets and walls for a streamlined appearance, and to ensure there is enough room to fully open doors and drawers. They're especially useful if your walls aren't perfectly straight.

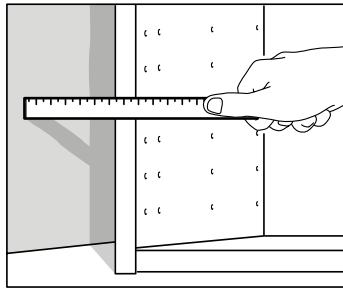

Check the wall with your spirit level to see if it is straight. If the wall is even, measure between the wall and the cabinet and mark this distance at the top and bottom of the filler piece.

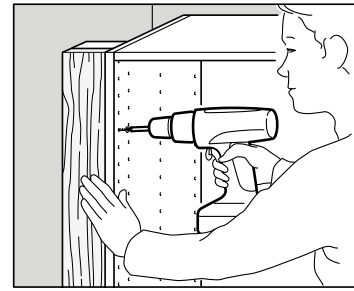

To ensure the filler piece stays in place, first fasten a support strip to the wall. Drill holes in the cabinet for the screws you'll use to fasten the cabinet and filler piece together. Put the filler piece into place. Put screws through the holes you have drilled. When all your filler pieces are in, caulk around each one with silicone for an airtight seal.

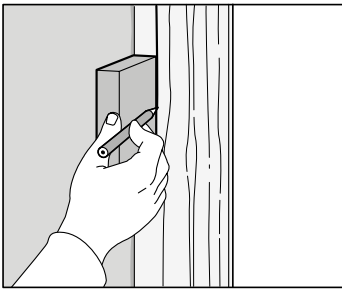

If the wall isn't level and flat, the filler piece must be cut to fit to the wall's shape. To do this, you'll need a filler piece, measuring tape, small block of wood about 1¼" thick and pencil.

Cut the filler piece so it's the same height as the cabinet. Place the edge of the filler piece against the wall. Hold the block of wood flat against the wall with the pencil against it. Keep them pressed against the wall as you slide them down the length of the filler piece. Now you have traced the shape of the wall onto the filler piece. Cut along your trace line.

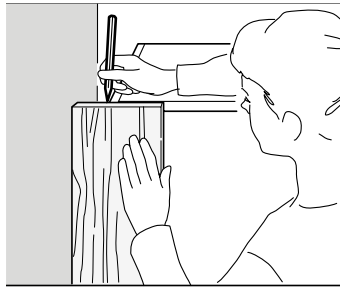

Place the newly cut edge of the filler piece against the wall (it should fit perfectly). Mark the edge of the cabinet on the top and bottom of the filler piece. Draw a straight line from these points and cut.

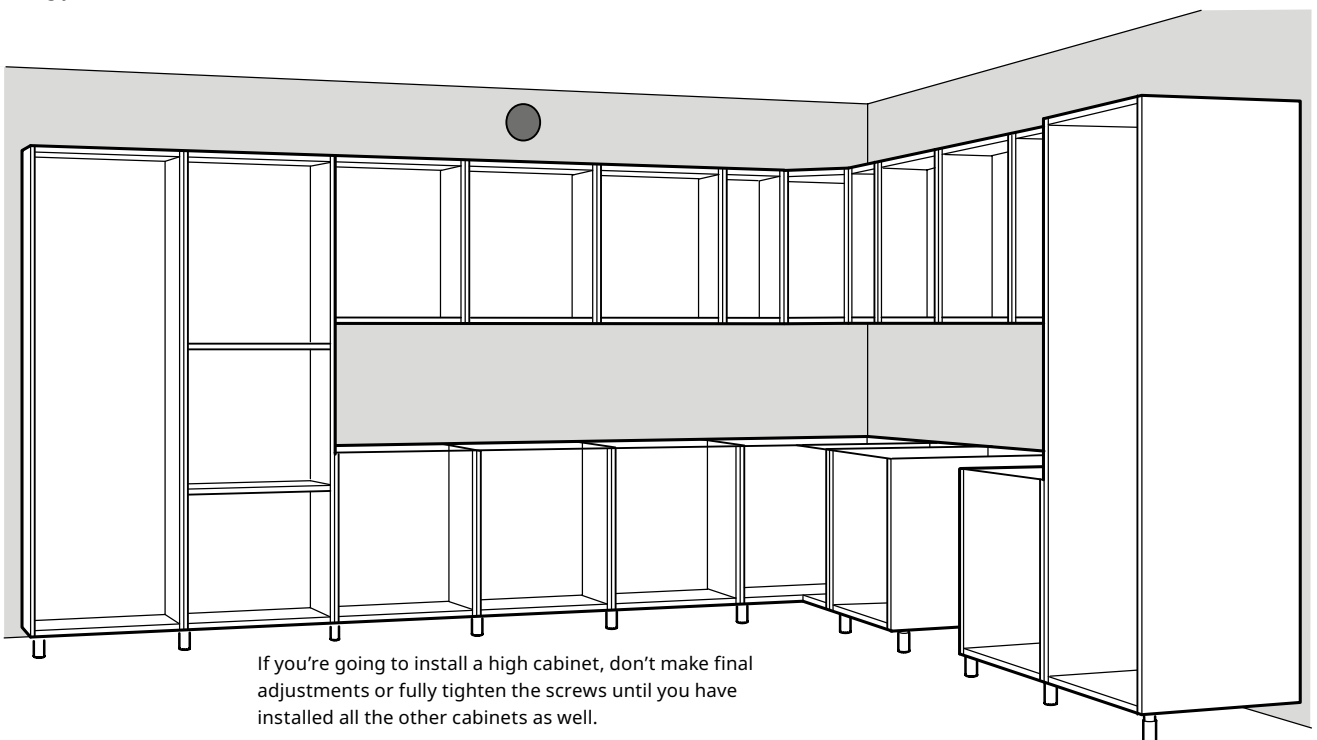

If you're going to install a high cabinet, don't make final adjustments or fully tighten the screws until you have installed all the other cabinets as well.

Install your countertop, sink, lighting and appliances

With your cabinet frames in, it's time to install your countertop, sink, lighting and appliances. Check that your countertop is the correct size before fitting it in place. Now is also the time if you need to customize your countertop for a sink or cooktop. **Note!** Always use your assembly instructions for help.

Once your countertop is in, you're ready to get your water, gas, lighting and appliances connected. All water, gas and electricity connections must be done by qualified professionals according to valid local safety regulations.

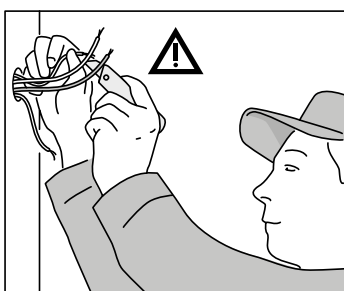

All electrical connections must be made by a qualified electrician.

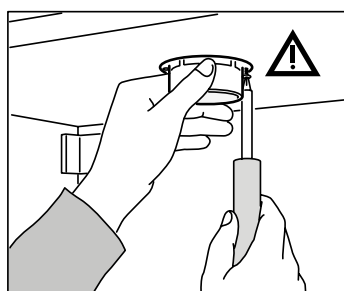

Install your lighting and appliances. If drilling holes, use a piece of wood to meet the drill as it penetrates the surface to avoid the edges splintering.

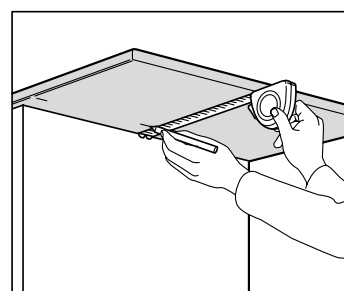

Proof measure your countertop. If you have a pre-cut countertop now is the time to cut it to the right length. To avoid splinter, cut with the countertop underside facing up when using a buzz or jig saw, but with the top if using a handsaw.

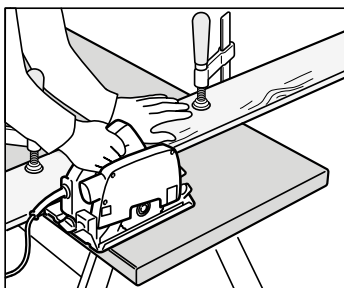

Use a circular saw and G clamps to hold a straight-edge to your pre-cut countertop when you cut to customize the size. It's helpful to use a pair of sawhorses to help you. A tip is to have a second person holding the piece to be cut off to avoid the edge splintering.

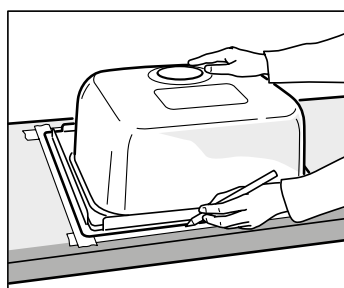

Mark a spot for the sink by laying the countertop in place. Trace the inside of the base cabinet onto the underside of the countertop. This helps you align your sink. Turn your countertop over and trace the outline of your sink onto masking tape.

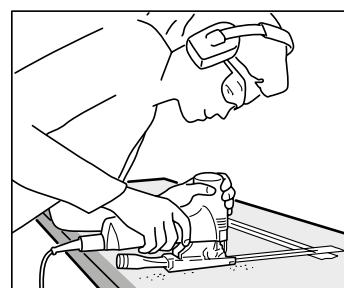

Use a jigsaw to cut out space for your sink. It's helpful to drill a hole on the inside corners of your outline before cutting, so you can make a cleaner cut.

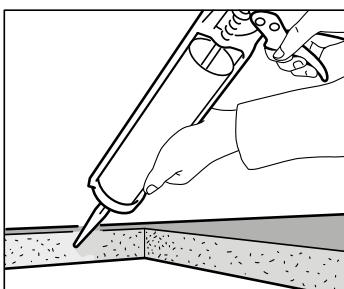

To prevent moisture from penetrating the countertop apply polyurethane silicone across the sawn edges.

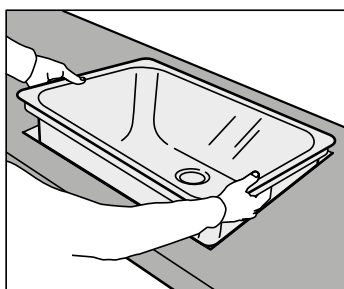

Install sink into the countertop according to the assembly instructions.

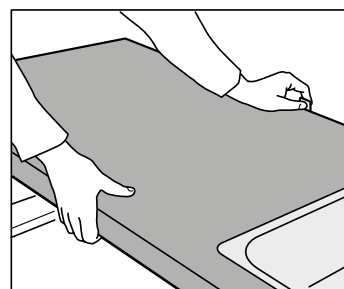

Secure your countertop in place according to the assembly instructions.

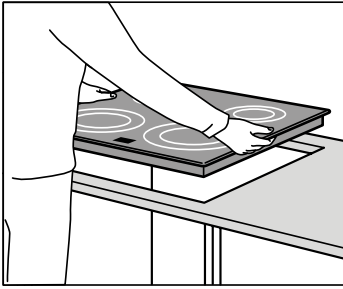

Customize your countertop for your cooktop in the same fashion as for your sink. See your cooktop's assembly instructions for help.

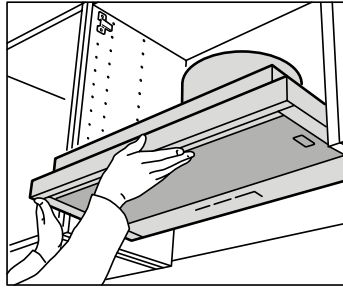

Install the exhaust hood. The exhaust hoods at IKEA can be installed in two ways: either ducted to the outside, called extraction, or used in recirculation mode fitted with a charcoal filter. Each installation option is described in the assembly instructions that come with the product.

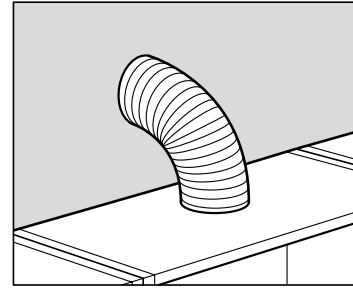

Saw the hole either in the back panel or in the top of the cabinet. See the assembly instructions. For safety and functionality reasons, follow precise measurements in the instructions for installation that come with the exhaust hood/fan.

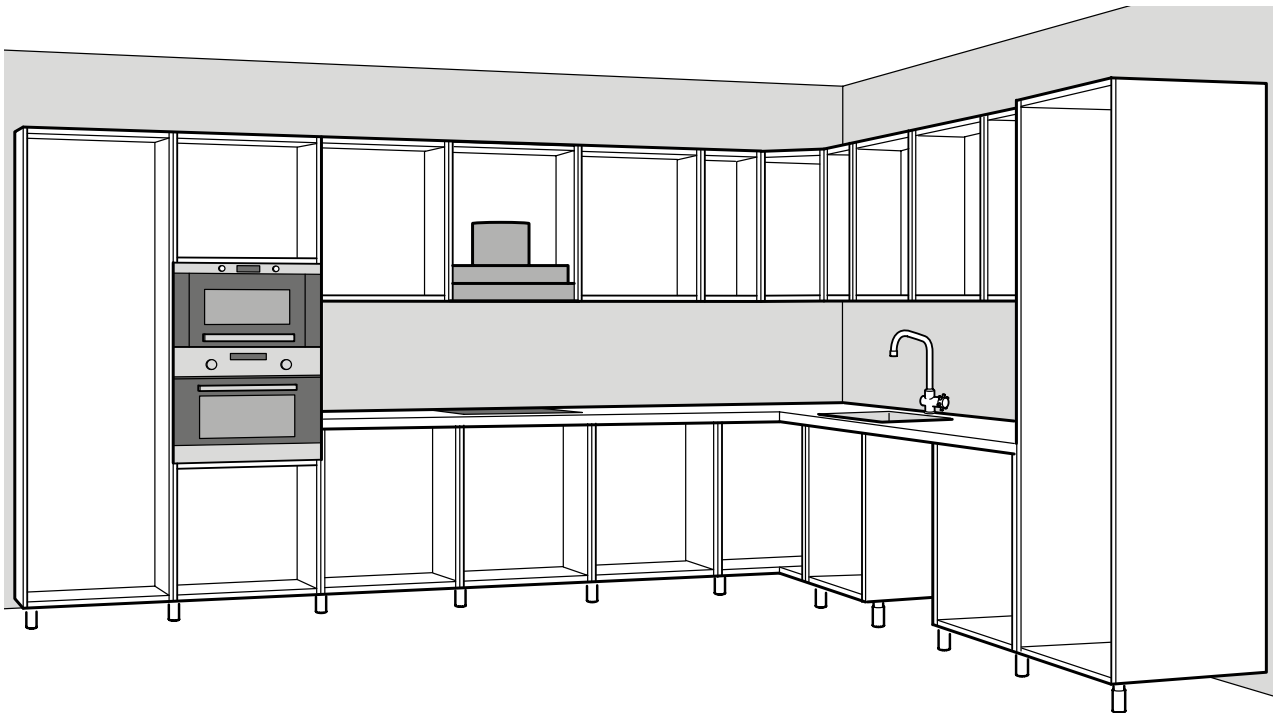

Kitchen island

If you're planning for a kitchen island we have supporting brackets to fasten it firmly to the floor. Legs/toekicks must then be fitted around the outside of the island.

You can use SEKTION assembly kit for kitchen island. The latter is used to connect cabinets back to back, or for attaching a cover panel to the back of cabinets.

Contact your local IKEA store if you need help regarding the assembly.

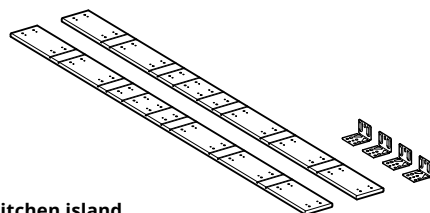

SEKTION Assembly kit for kitchen island
002.984.11

Good to know

If you're installing a kitchen island, it must be secured to the floor by building a toekick frame. Fasten the toekick frame to both the floor and the cabinets. When attaching the frame to the floor be aware of amenities like floor heating or plumbing already installed.

Install your shelves, drawers, doors, knobs and handles

Now your cabinet frames, countertops and appliances are in, fit your drawer slides into your cabinets. Remember that the slides for inner drawers and standard drawers are fitted in different ways. Once the slides are in, fit in your

drawers before your doors and shelves. Finish up by adding knobs and handles as well as any other internal solutions (like wire baskets).

Note! Always use your assembly instructions for help.

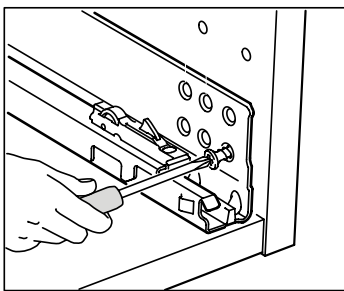

Fasten your drawer slides, starting with your outer drawers. Outer drawer slides should be attached to the outer row of holes in your cabinet.

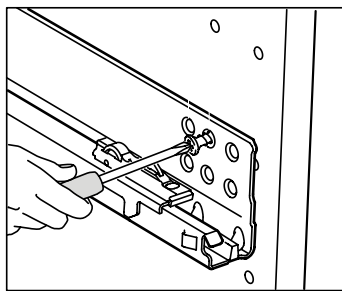

Once your outer drawer slides are in, fit your inner drawer slides. The inner drawer slides are fitted to the inner row of holes in your cabinet.

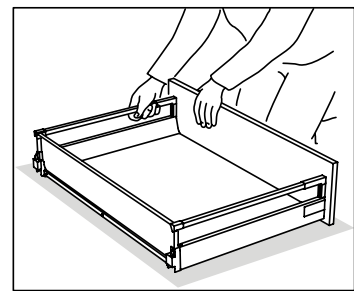

Assemble your doors and drawers.

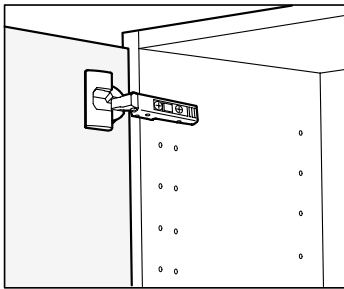

Attach the hinges for your doors.

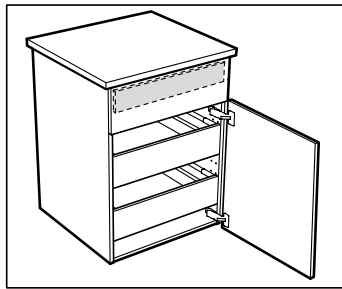

Fit your drawers and doors to your cabinets.

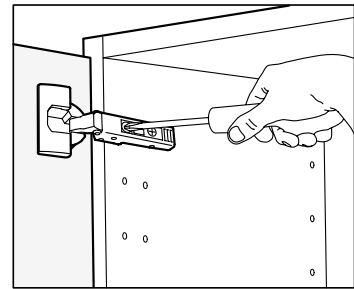

Align your doors to the correct height and width by adjusting the screws on the hinge plate.

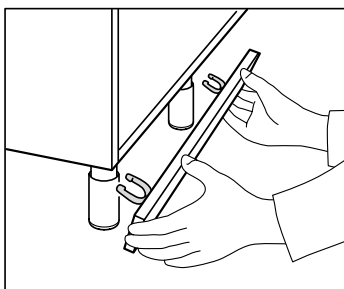

If you're fitting a toe kick now is the time to attach it. Follow the assembly instructions for help.

You're done! Congratulations on your new kitchen!

Caring for your cabinets

Clean the doors, cabinet interiors and wood surfaces with a soft, damp cloth. Only use cleaning products intended for these materials. Do not use products that contain ammonia, alcohol, bleach or abrasives. Rinse with clean water, then dry with a clean, dry cloth. Make sure to clean up spills quickly.

Keep your sink sparkling

After each use, wipe the sink clean with a cloth or sponge dampened in water or a non-abrasive detergent, if necessary. Rinse the bowl with water and then wipe the sink with a dry cloth. Avoid scouring-powder, steel wool, or hard objects which can scratch the stainless steel surface. The damp surface can be discolored if substances containing iron, such as steel wool, nails or gravel, are allowed to remain on it. Discoloration is caused by the foreign material.

Long-lasting countertops

Keep your countertop in top condition by cleaning spills quickly with water and a mild detergent. Be sure to keep them as dry as possible after use. For wood and solid wood worktops use BEHANDLA wood treatment oil. The oil protects the wood from marks, stains and cracks, and prevents water from penetrating the surface.

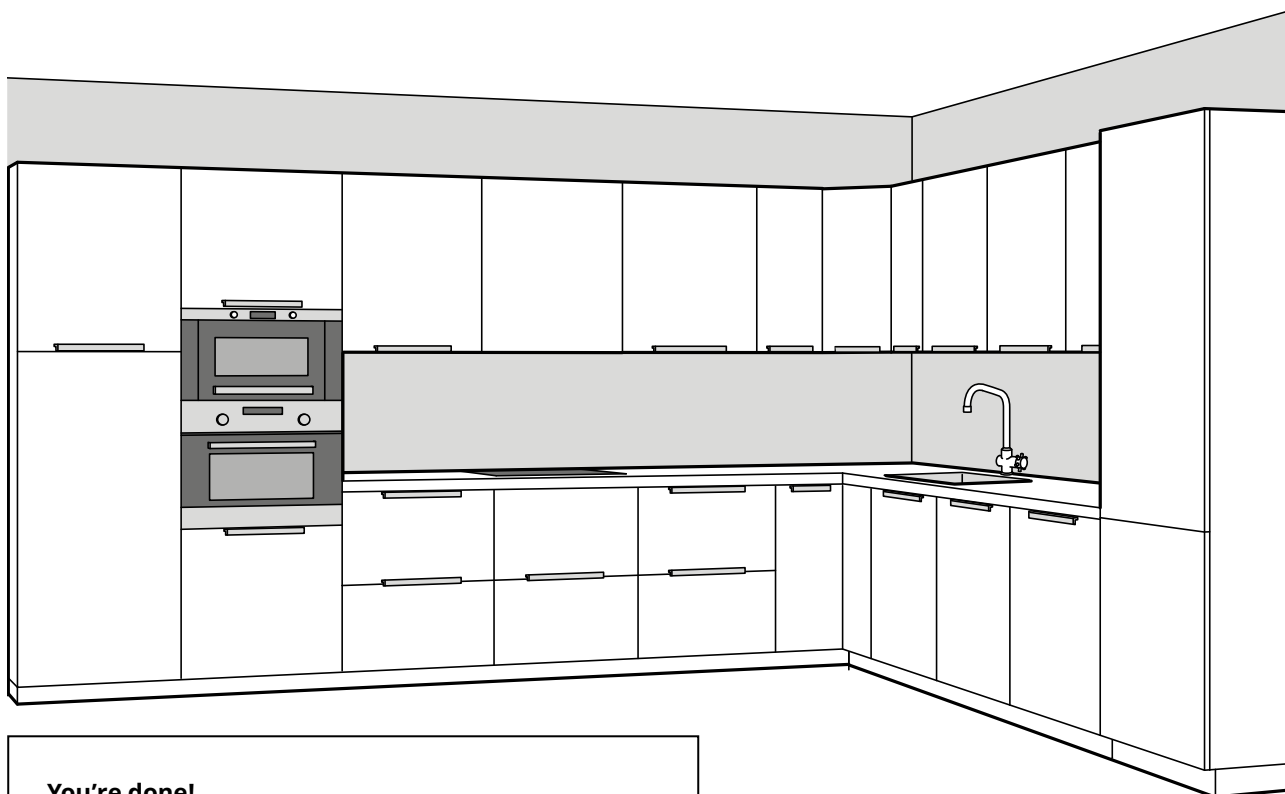

You're done!

Time to step back and admire your new kitchen – and admire yourself for saving so much money by assembling and installing it yourself! With a little care and maintenance your new IKEA kitchen will keep looking its best for many years to come.

Services

Our kitchen services give you the freedom to choose not only the products that suit you, but also decide how much you want to do yourself and how much you want us to do for you. Find the different services that we can offer to help and support you.

→ For more details about our services, talk to a co-worker at your local IKEA store or visit [IKEA-USA.com/kitchenservices](https://www.ikea.com/us/en/kitchenservices)

Kitchen Measurement Service

It's important to have your kitchen accurately measured before planning begins. An experienced IKEA Measurement Technician will come to your home, take all of the essential measurements, and enter the data in the IKEA Home Planner. Your Measurement Service fee is refunded when you have IKEA install your kitchen. Available for customers living within our service area.

Free Kitchen Planning Service

We offer two **no cost** options to have your kitchen professionally planned. You will receive a detailed layout of your kitchen including cabinets, appliances, and countertops, and a parts list to make it easy to order.

Most Convenient & available to everyone in the continental US:

Planning from Your Home Make a 90-minute appointment, online or in your local IKEA store. Allow time for you to measure your kitchen and select products before your appointment. A professional IKEA Kitchen Planner will work with you interactively online to plan your dream kitchen. You will be able to discuss every detail and view your plan being created. Your planner will follow-up with a second session to make any changes.

Visit an IKEA store:

Planning from the Store You can make an appointment online or at your local IKEA store for a two-hour in-store appointment with one of our professional IKEA Kitchen Planners. Allow time for measuring your kitchen and selecting products before your planning appointment.

Prior to your appointment, you will need to:

• **Measure your space** – The first step is getting your kitchen measurements. Instructions will be provided if you want to do this yourself. But if you live in an IKEA service area, a professional IKEA measurement technician can visit your home to measure your kitchen for you.

• **Choose your products** – Start browsing our kitchen products now to get a better understanding of what you want. You must know this before your planning session to make it productive.

Installation Price Quote

Upon completion of your Kitchen Plan on our IKEA Home Planner, we can schedule your Installation Price Quote. An experienced professional from IKEA will contact you and provide an itemized installation price quotation.

Installation Price Quote

- Confirmation of the scope of kitchen installation.
- Confirmation of the time schedule of kitchen installation.
- Confirmation of the price of kitchen installation.

IKEA Kitchen Installation Service

Professional IKEA kitchen installation makes your dream kitchen come true. Check with your local store to see if installation is available in your area. Professional kitchen installers will handle assembling and installing your IKEA cabinets, doors, drawers, interior fittings, handles and knobs. Your kitchen will be installed to the highest industry standards.

Kitchen installation includes:

- Assemble cabinets, drawers, doors and interior fittings
- Install IKEA cabinets, toe kicks and side cover panels (excludes 26x36" and 36x96" panels)
- Adjust all IKEA cabinet doors and drawer fronts for appearance
- Clean-up of your kitchen job site, which includes:
 - Daily broom cleaning of job site
 - Vacuum inside of cabinets, floors, and other surfaces upon completion of installation
- Attach IKEA knobs and/or handles to cabinet doors and drawers

5-Year Installation Warranty

Professional Kitchen Installers are professional, licensed, insured and warranty their work for 5 years post completion on IKEA supplied kitchen products.*

*Installation warranty is for the installation of IKEA kitchen products only. In the event of defects in workmanship, the IKEA product or materials will be repaired or replaced; provided, that the defect was not due to a product defect, normal wear and tear, accidents, alteration by the customer, misuse, abuse, or neglect.

Delivery

Whether you're shopping in the store or online, and no matter how big the purchase, we can help do the heavy lifting and arrange delivery, by an Independent Service Provider, to your home or business.

IKEA Projekt Credit Card

Your dream home is now within reach. With the special financing options on our IKEA Projekt credit card**, you don't have to put off loving every room in your home.

**Subject to credit approval.

IKEA Projekt Credit Card Accounts are issued by Comenity Capital Bank.

To learn more visit [IKEA-USA.com/creditcard](https://www.ikea.com/us/en/creditcard) or drop by your local store.

Services and prices may vary. For more information about our services, visit [IKEA-USA.com/services](https://www.ikea.com/us/en/services) or your local IKEA store.